

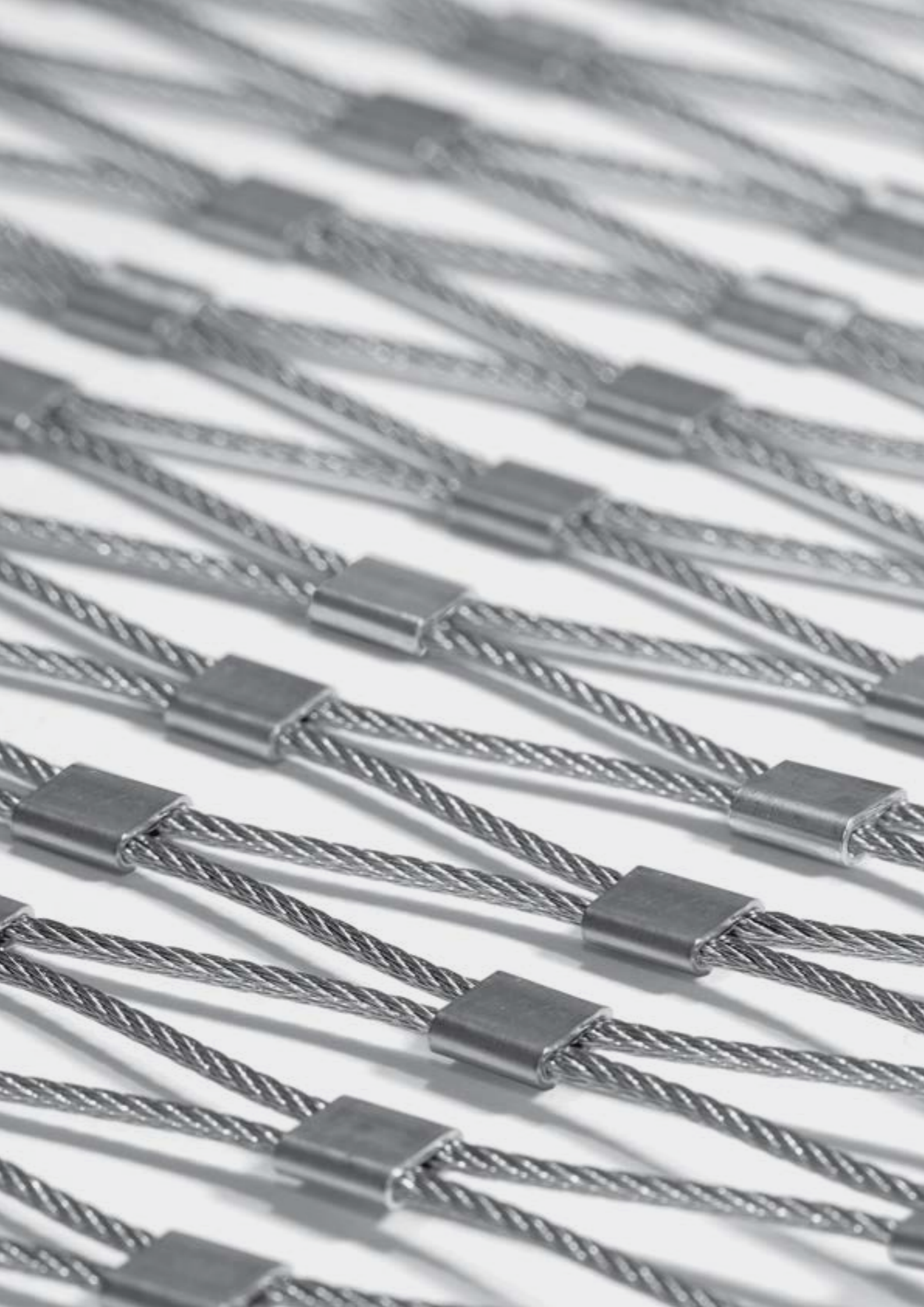

**I-NET STAINLESS STEEL  
NET SYSTEMS**



## CONTENT

## PAGE

• <b>Who we are ?</b>	
Our Company .....	-4-
• <b>What we do ?</b>	
Consulting .....	-5-
Planning & Design .....	-6-
Static Calculations .....	-7-
Production .....	-7-
Installation .....	-8/9-
• <b>I-NET Stainless Steel Net Systems</b> .....	-12-
I-NET Technical & Geometrical Details .....	-14-
I-NET Components .....	-15-
I-NET General Information .....	-16-
I-NET Comparison .....	-17-
Order Data Sheet .....	-18/19-
I-NET Directions & Endings .....	-20/23-
Border Ropes & Assembly Details / Closing Details .....	-24/25-
I-NET Frame Systems .....	-26/28-
• <b>Characteristics of Wire Ropes</b>	
Explanation & Application of Wire Ropes .....	-30/31-
Technical Information about Wire Ropes .....	-32-
• <b>Overview of Stainless Steel</b>	
Material .....	-34-
Corrosion .....	-36-
Maintenance & Cleaning .....	-37-
• <b>Technical Tips</b>	
Rope Forces & Tensioning .....	-38-
Tightening & Loosening Description of Rope System .....	-38-
• <b>Assembly Lengths</b> .....	-39-
• <b>Our Goals</b> .....	-41-



- **Who we are ?**

INOX-NET is a young and dynamic company specializing in architectural stainless steel net and rope systems. Our aim is to provide innovative, cost-effective, environmentally friendly, and long-lasting products with excellent quality. Stainless Steel Net and Rope Systems provide suitable solutions for many types of architectural projects by their features such as flexibility, durability, high quality, and lightweight.

INOX-NET is interested to be your solution partner from the smallest volume individual projects to the most unique and challenging projects from all over the world.

**Our Company ;**

INOX-NET is experienced in architectural applications involving stainless steel net and rope systems. We provide services and solutions in many architectural projects ranging from balustrades, safety nets, facades, greenery, decoration and zoo enclosures.

- **What we do ?**

INOX-NET provides A to Z services from consulting, design and planning, static calculations to production and installation for customers all over the world who want to give life to their innovative ideas and imaginations.

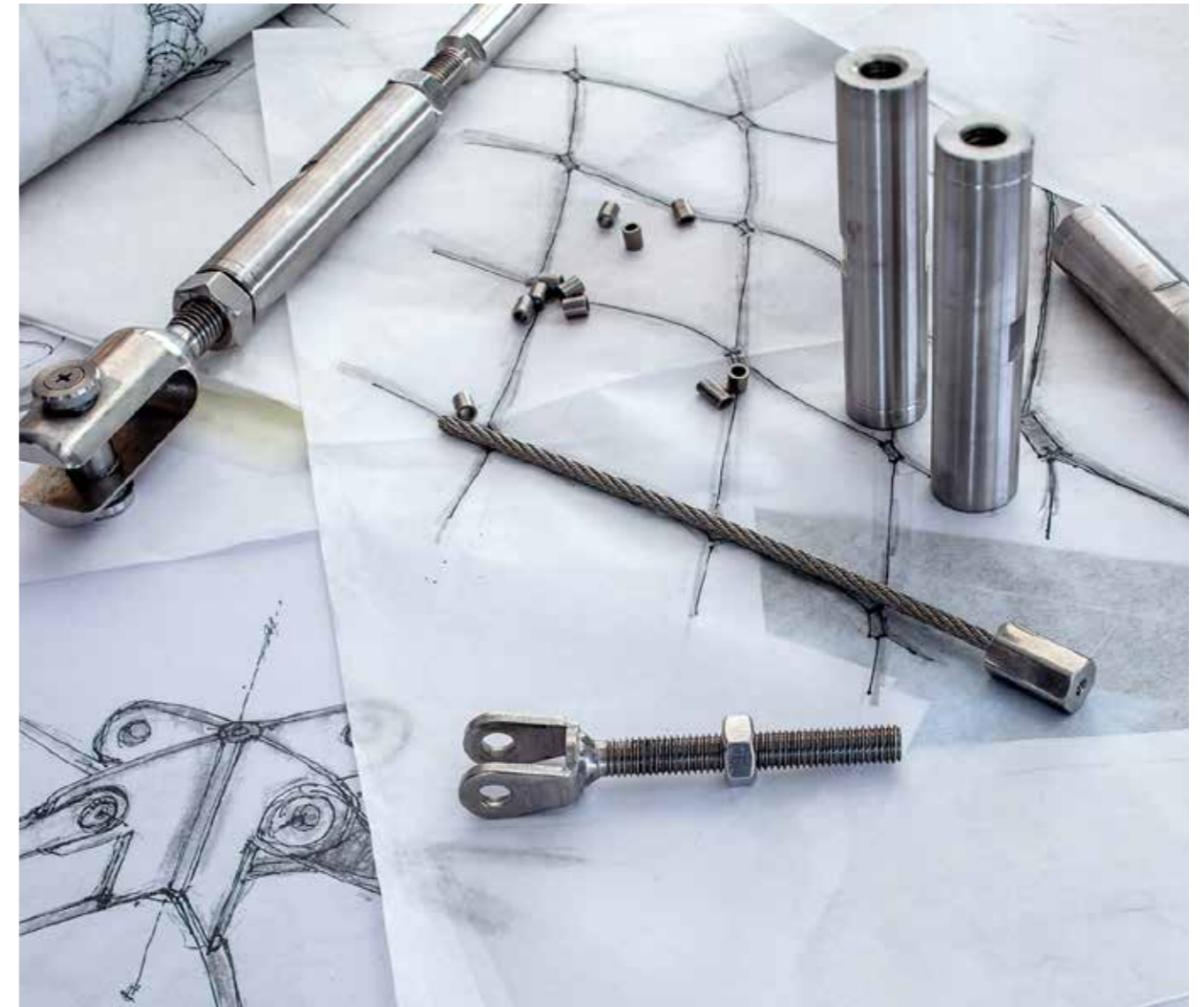

**Consulting ;**

We provide consultancy services to architects, architectural design offices and contractors to fulfill their needs and guide their imagination. The consulting service we provide begins from the first idea of the architectural design project and lasts through the planning stage to the realization stage. We are always happy to share our ideas with you whether through phone, via email, or if you like face to face in our offices.

## Planning & Design

The INOX-NET planning process includes:

- **DESIGN AND SYSTEM DEVELOPMENT,**
- **PLANNING SUPPORT,**
- **ADMINISTRATIVE PLANNING,**
- **PROJECT APPLICATION FOR ROPES, NETS AND STEEL WORKS,**
- **INSTALLATION PLANNING.**

INOX-NET services are always customer focused and our specialists are actively involved in the whole process from the beginning. Besides providing standard products, INOX-NET also provides custom design stainless steel net and stainless steel rope application concepts if so desired.



## Static Calculations

INOX-NET can perform structural static calculations for all kinds of stainless steel net and rope projects when needed.

Our static analysis services are:

- **SYSTEM DEVELOPMENT,**
- **SHAPING OF STAINLESS STEEL NETS AND NET STRUCTURES,**
- **SIZING OF NET AND ROPE LOADS,**
- **CALCULATION OF ADDITIONAL COSTS,**
- **VERIFIABLE STRUCTURAL STATIC CALCULATIONS.**

## Production

After approval of the production drawings, they are delivered to the production department and productions start immediately according to these plans. Each net part is produced according to the desired measurements, diamond direction, and net ending features. I-ROPE systems are also produced by taking attention to the pin to pin measurements and pre-tension loads resulting from the static calculations.



## Installation

- Self-Assembly by the customer,
- Installation training,
- Installation support.
- Installation supervision,
- Turn-key installation by INOX-NET.

According to customer preference, INOX-NET Stainless Steel Ropes and Net Systems can be installed on site by our experienced installation team.

**Stainless, Ageless, Elegant, Durable, Solid & Transparent.**

*Istanbul 3.rd Airport I-ROPE Installation*

**BEHIND EVERY INNOVATIVE PRODUCT**

**THERE IS A CREATIVE SOLUTION.**



**I-NET STAINLESS STEEL NET SYSTEMS**

## I-NET Stainless Steel Net Systems

Lightweight, flexible, transparent, durable, and long-lasting I-NET is being created by knitting high quality stainless steel rope and stainless steel ferrules. I-NET is one of the most preferred materials for wide visioned architects and designers who want to give shape to their limitless imaginations. With the flexibility and curvature features of the I-NET stainless steel net, it can move in opposite directions allowing it to flex and change to the desired geometric form. Thus, it can be used in large areas without the need for any auxiliary substructures.

I-NET is produced with different net widths and rope diameters depending on the application field.



I-NET is a suitable material from railing fillings to,

- **DURABLE,**
- **TRANSPARENT,**
- **LIGHTWEIGHT**

facade structures, up to free-form zoo structures. I-NET provides solutions to a wide range of application fields.

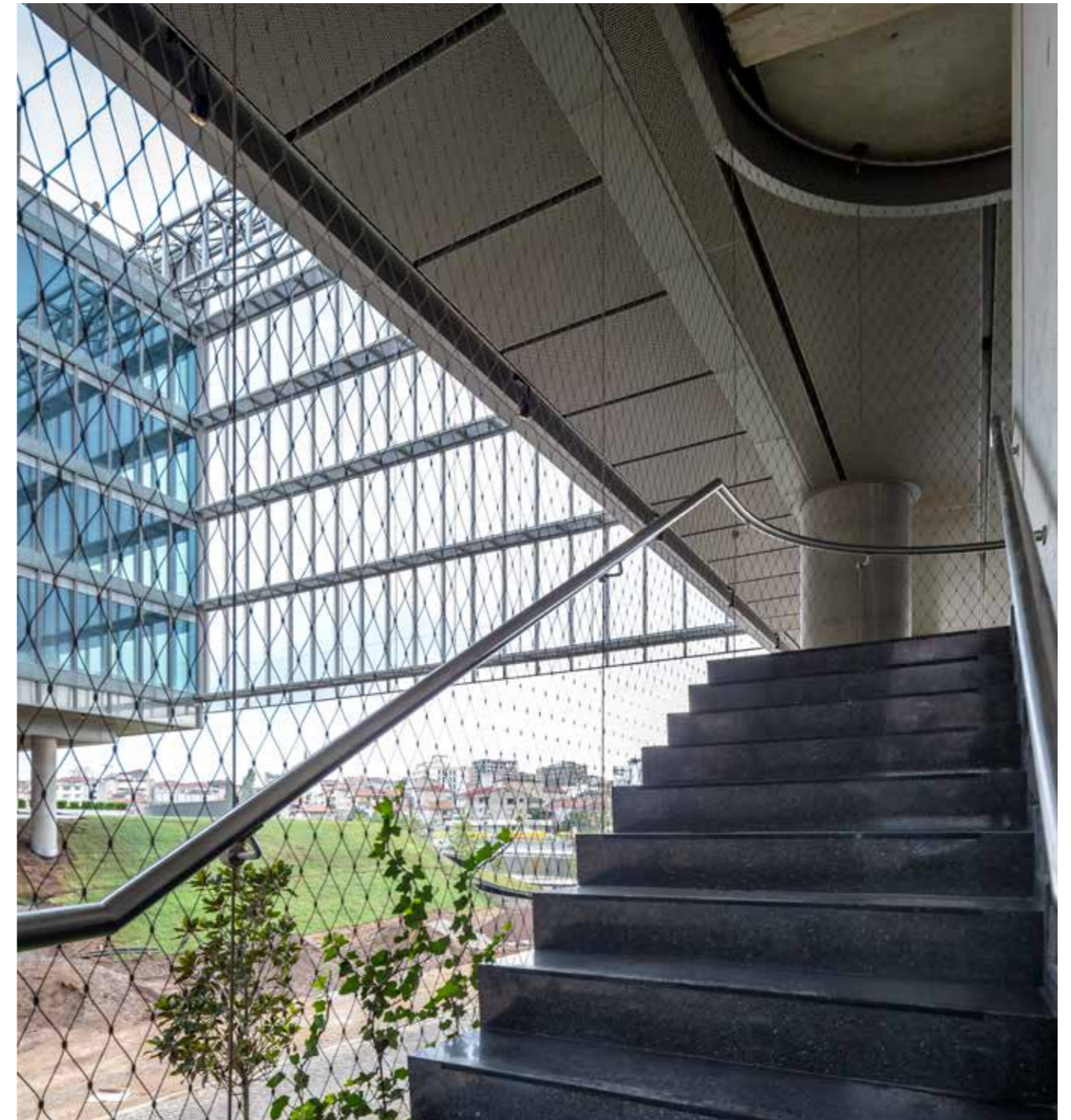

*T. Garanti Bank Pendik Technology Campus / Pendik - İSTANBUL*

The most common applications for I-NET Stainless Steel Net are:

- **BALUSTRADES,**
- **SAFETY NETS,**
- **FACADES,**
- **GREENERIES,**
- **DECORATIVE DESIGNS,**
- **ZOO ENCLOSURES,**

# I-NET TECHNICAL & GEOMETRICAL DETAILS

I-NET  
AISI 316 Stainless Steel Rope



Rope 7x7 for  
1,50 mm and 2,00 mm

I-NET  
AISI 316 Stainless Steel Rope



Rope 7x19 for  
3,00 mm and 4mm

## ROPES

Part Number	Rope (Ømm)	Material	Construction	F (kN)	MQ mm <sup>2</sup>	S (N/mm <sup>2</sup> )
IR-102-0150	1,5	AISI 316	7x7	1,86	0,97	1570
IR-102-0200	2	AISI 316	7x7	2,88	1,73	1570
IR-103-0300	3	AISI 316	7x19	4,69	3,73	1570
IR-103-0400	4	AISI 316	7x19	8,34	6,63	1570

*F* = Breaking load  
*MQ* = Metallic cross section  
*S* = Nominal strength of the individual wires

## FERRULES

Part Number	Rope (Ømm)	Material	Node Strength F1(kN)	Node Strength F2(kN)	Diameter Ø (mm)	Length (mm)
IN-115-0150	1,5	AISI 316L	0,21	2,26	5	6,4
IN-115-0200	2	AISI 316L	0,28	3,78	6	7,8
IN-115-0300	3	AISI 316L	0,45	7,9	8	11

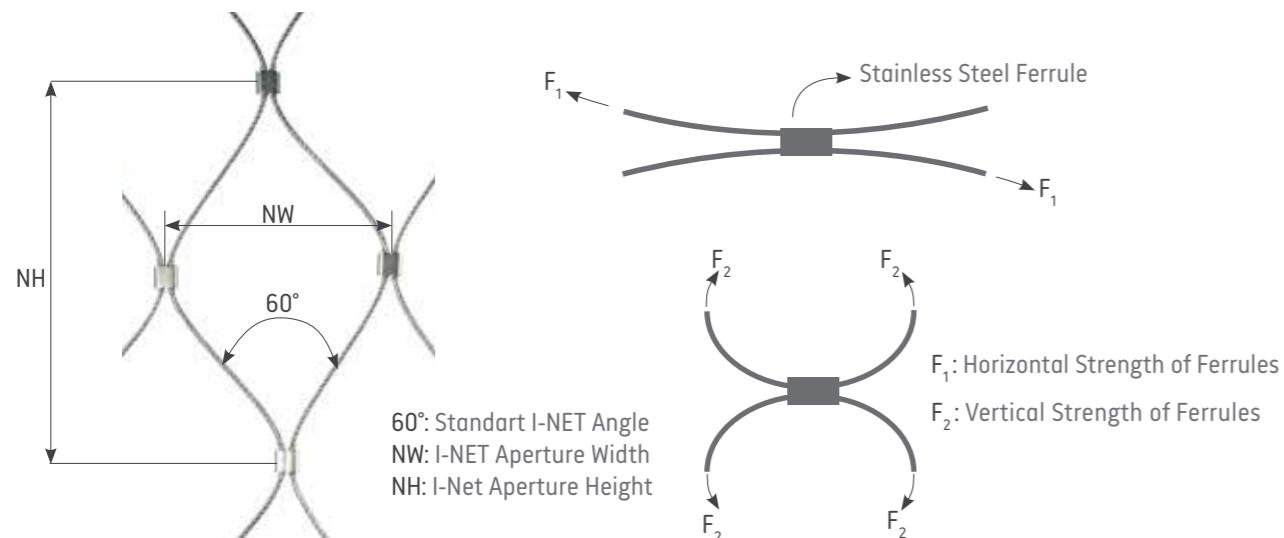

The standard diameters of rope used in I-NET stainless steel nets are produced as 1.5 mm, 2 mm, 3 mm or 4 mm. Producing net width of 25 to 200mm (or larger) is possible depending on the rope diameter. The material class of I-NET is 1.4401.

# I-NET Components

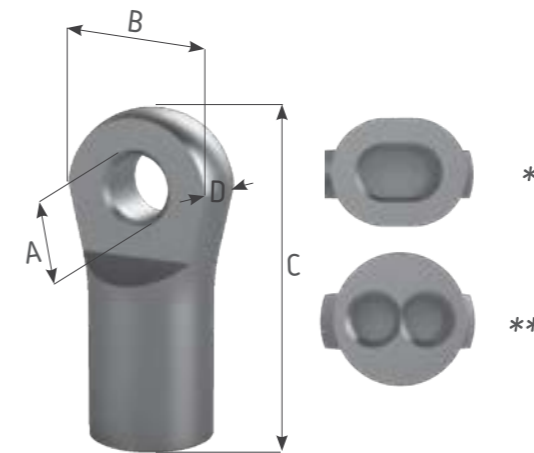
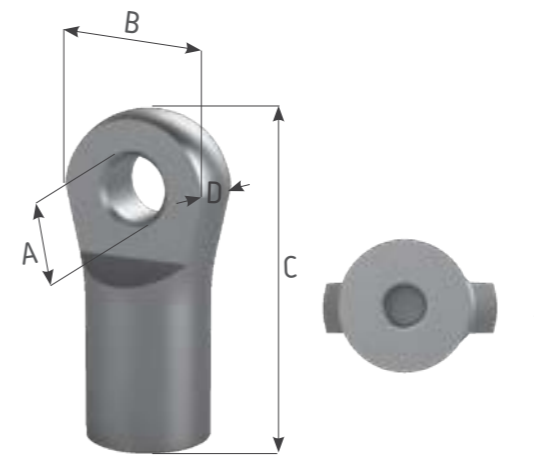
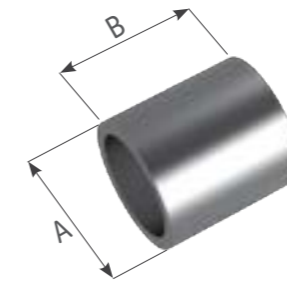

Single 1.5, 2 and 3mm



Double 1.5 and 2mm



Double 3 mm

## I-NET FERRULE

Part Number	Rope (Ømm)	Dimensions in mm	
		A	B
IN-115-0150	1,5	5	6,4
IN-115-0200	2	6	7,8
IN-115-0300	3	8	11

Material AISI 316 L

## I-NET EYELET SINGLE

Part Number	Rope (Ømm)	Dimensions in mm			
		A	B	C	D
*IN-116-0150	1,5	3,1	7,8	15,85	3
*IN-116-0200	2	4,55	10,62	21	3
*IN-116-0300	3	6	14,4	31	4,95

Material AISI 316 L

## I-NET EYELET DOUBLE

Part Number	Rope (Ømm)	Dimensions in mm			
		A	B	C	D
**IN-117-0150	1,5	3,1	7,8	15,85	3
**IN-117-0200	2	4,55	10,62	21	3
***IN-117-0300	3	6	14,4	31	4,95

Material AISI 316 L



## I-NET General Information

Part Number	Rope Ø mm	NW X NH mm	Weight kg/m <sup>2</sup>	Transparency %
IN-110-150-025	1,5	25 x 43	1,71	82,6
IN-110-150-030	1,5	30 x 52	1,31	85,9
IN-110-150-040	1,5	40 x 69	0,87	89,9
IN-110-150-050	1,5	50 x 87	0,64	92,2
IN-110-150-060	1,5	60 x 104	0,5	93,7
IN-110-150-070	1,5	70 x 121	0,41	94,6
IN-110-150-080	1,5	80 x 139	0,35	95,3
IN-110-150-100	1,5	100 x 173	0,27	96,3
IN-110-150-120	1,5	120 x 208	0,22	97
IN-110-150-140	1,5	140 x 242	0,18	97,5
IN-110-150-160	1,5	160 x 277	0,15	97,8
IN-110-150-180	1,5	180 x 312	0,14	98
IN-110-150-200	1,5	200 x 346	0,12	98,9
IN-110-200-040	2	40 x 69	1,45	86,1
IN-110-200-050	2	50 x 87	1,07	89,3
IN-110-200-060	2	60 x 104	0,85	91,4
IN-110-200-070	2	70 x 121	0,7	92,6
IN-110-200-080	2	80 x 139	0,6	93,6
IN-110-200-100	2	100 x 173	0,45	95
IN-110-200-120	2	120 x 208	0,36	95,9
IN-110-200-140	2	140 x 242	0,3	96,6
IN-110-200-160	2	160 x 277	0,26	97,1
IN-110-200-180	2	180 x 312	0,23	97,3
IN-110-200-200	2	200 x 346	0,2	97,8
IN-110-300-050	3	50 x 87	2,48	85
IN-110-300-060	3	60 x 104	1,94	87,1
IN-110-300-070	3	70 x 121	1,59	89
IN-110-300-080	3	80 x 139	1,34	90,5
IN-110-300-100	3	100 x 173	1,01	92,6
IN-110-300-120	3	120 x 208	0,81	93,9
IN-110-300-140	3	140 x 242	0,68	94,9
IN-110-300-160	3	160 x 277	0,58	95,6
IN-110-300-180	3	180 x 312	0,51	95,9
IN-110-300-200	3	200 x 346	0,45	95

Part Number : IN - 000 - 000 - 000

- Net Width
- Rope Diameter
- Code No
- I-NET

## I-NET Comparison



I-NET 40mm with 1,5mm rope diameter



I-NET 40mm with 2mm rope diameter



I-NET 60mm with 1,5mm rope diameter



I-NET 60mm with 2mm rope diameter



I-NET 80mm with 2mm rope diameter



I-NET 80mm with 3mm rope diameter



# ORDER DATA SHEET

To provide a better service, please indicate following information when ordering stainless steel net systems. If you have any specific inquiry please contact us..

## 1. I-NET Measurements

### Outer Border / Frame Dimensions

Rectangular : **H** (Height in mm) x **L** (Length in mm)

Parallelogram : **H** (Height in mm) x **L** (Length in mm) x  $\alpha$  (inclination angle)

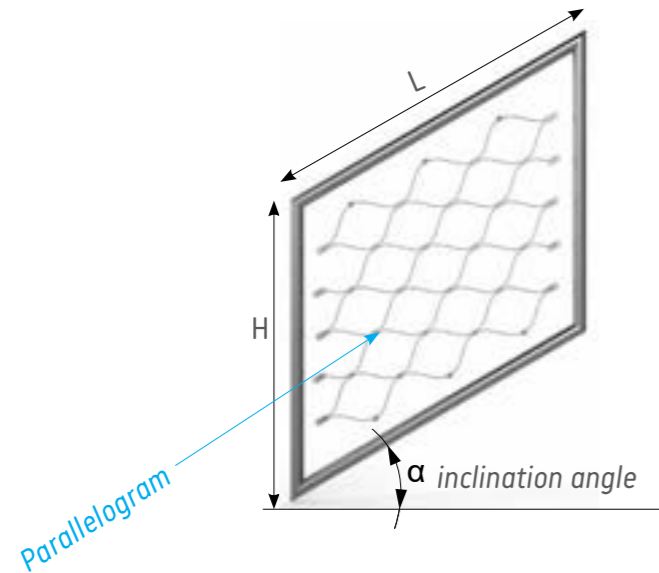

For special shapes please share drawings.

## 2. I-NET Type

**Rope Diameter:** : (See page 16)

**Net Width** : (See page 16)

**Net Direction and Endings** : (See page 20,21,22,23)

## 3. Border Details

**Border Rope and Assembly Details:** (See page 24 and 25)

**Frame System (Round and inviss):** (See page 26 and 28)

## Additional for Installation

**Installation Cable** : Rope diameter (See page 14)

**Ferrules** : Type / dimension (See page 15)

**Eyelets** : Type / dimension (See page 15)

To order I-NET please refer to following code system to identify part number.

## I-NET Part Number Description

IN	Code No.	Rope Diameter	Net Width	Net Direction & Endings
I-NET	110	1,5 mm	25 x 43 mm	<b>H1</b> (Horizontal diamond direction, both sides open cable endings)
		2 mm	30 x 52 mm	<b>H2</b> (Horizontal diamond direction, one side open, other side closed with loose ferrules)
		3 mm	40 x 69 mm	<b>H3</b> (Horizontal diamond direction, both sides closed with loose ferrules)
			50 x 87 mm	<b>H4</b> (Horizontal diamond direction, one side open cable, other side closed with eyelets)
			60 x 104 mm	<b>H5</b> (Horizontal diamond direction, both sides with eyelets)
			70 x 121 mm	<b>H6</b> (Horizontal diamond direction, one side closed with loose ferrules, other side closed with eyelets)
			80 x 139 mm	<b>V1</b> (Vertical diamond direction, both sides open cable endings)
			100 x 173 mm	<b>V2</b> (Vertical diamond direction, one side open, other side closed with loose ferrules)
			120 x 208 mm	<b>V3</b> (Vertical diamond direction, both sides closed with loose ferrules)
			140 x 242 mm	<b>V4</b> (Vertical diamond direction, one side open cable, other side closed with eyelets)
			160 x 277 mm	<b>V5</b> (Vertical diamond direction, both sides with eyelets)
			180 x 312 mm	<b>V6</b> (Vertical diamond direction, one side closed with loose ferrules, other side closed with eyelets)
			200 x 346 mm	<b>PH1</b> (Parallelogram net, horizontal diamond, all sides open cable endings)
				<b>PH2</b> (Parallelogram net, horizontal diamond, both side open closed with loose ferrules, both side open cable)
				<b>PH3</b> (Parallelogram net, horizontal diamond, all sides closed with eyelets)
				<b>PH4</b> (Parallelogram net, horizontal diamond, all sides closed with eyelets)
				<b>PH5</b> (Parallelogram net, horizontal diamond, all sides closed with eyelets)
				<b>PH6</b> (Parallelogram net, horizontal diamond, both side open closed with eyelets, both side closed with loose ferrules)
				<b>PV1</b> (Parallelogram net, vertical diamond, all sides closed with loose ferrules)
				<b>PV2</b> (Parallelogram net, vertical diamond, both sides open cable, both sides closed with loose ferrules)
				<b>PV3</b> (Parallelogram net, vertical diamond, both sides closed with loose ferrules, both sides closed with eyelets)
				<b>PV4</b> (Parallelogram net, vertical diamond, all sides closed with eyelets)

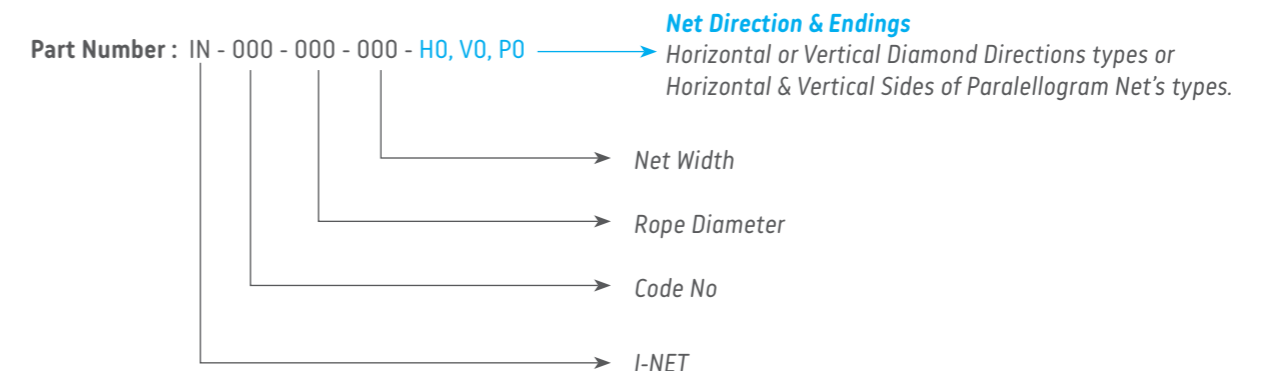

## I-NET Directions and Endings

### Horizontal Diamond I-NET Endings

The horizontal diamond net direction is commonly used at balustrade, greenery and decorative projects. It might be preferred for projects involving long continuous nets as an economic solution. Ending possibilities of horizontal diamond directed I-NET are as below;

**H1**

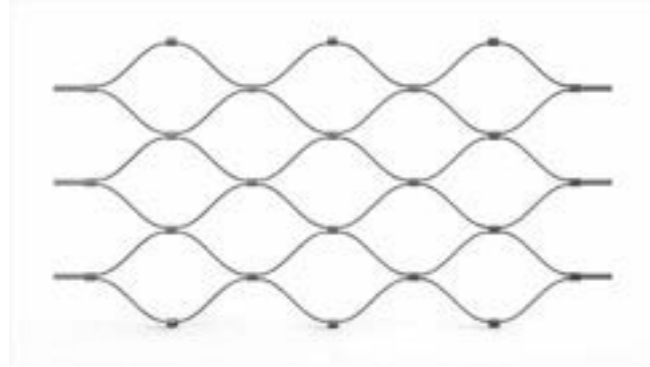

Both side open cable endings.

**H2**

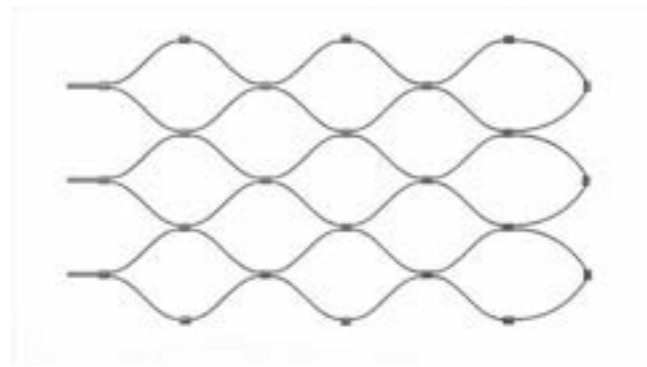

One side open cable, other side closed with loose ferrules.

**H3**

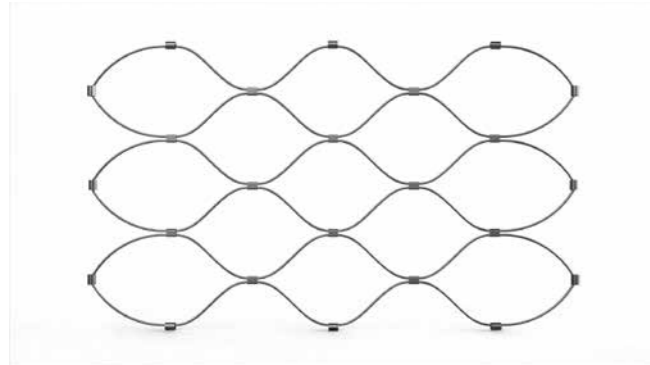

Both side closed with loose ferrules.

**H4**

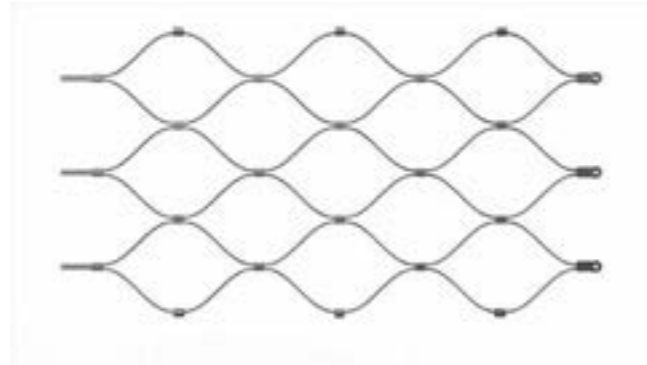

One side open cable, other side closed with eyelet.

**H5**

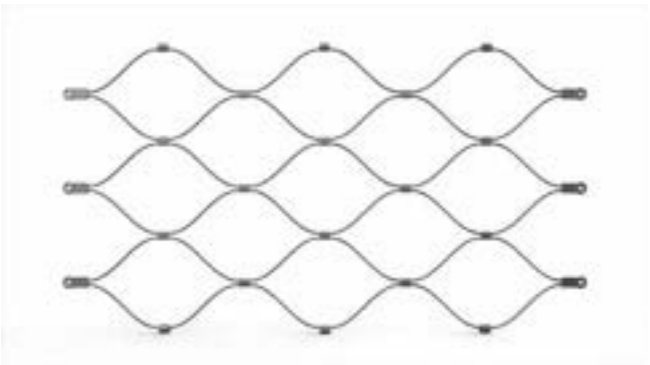

Both side closed with eyelet.

**H6**

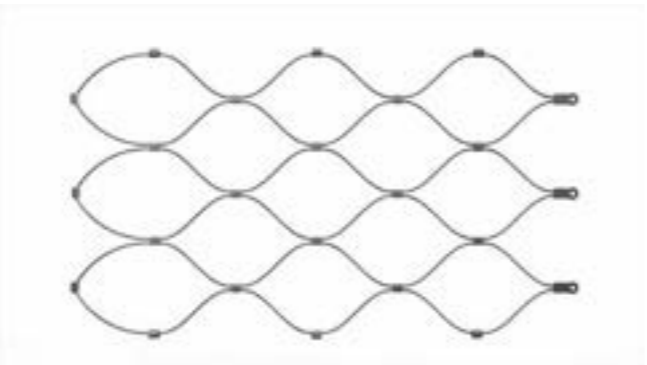

One side closed with loose ferrules, other side closed with eyelet.

## I-NET Directions and Endings

### Vertical Diamond I-NET Endings

The vertical diamond net direction is mostly preferred at safety requiring applications and facade projects. Ending possibilities of vertical diamond directed I-NET are as below

**V1**



Both side open cable endings.

**V2**



One side open cable, other side closed with loose ferrules.

**V3**

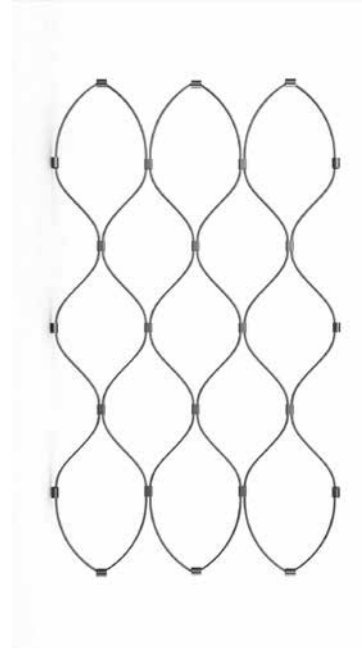

Both side closed with loose ferrules.

**V4**



One side open cable, other side closed with eyelet.

**V5**



Both side closed with eyelet.

**V6**

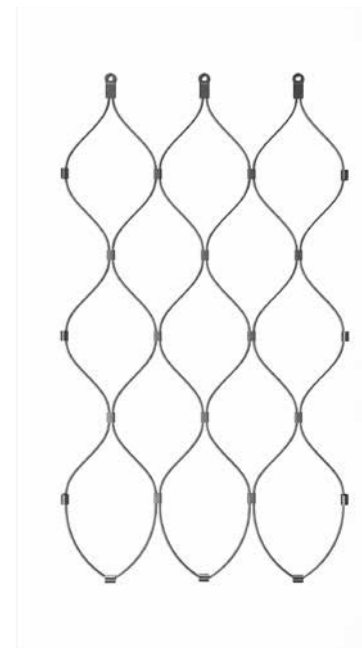

One side closed with loose ferrules other side closed with eyelet.

## I-NET Directions and Endings

### Horizontal Diamond Parallelograms I-NET Endings

Parallelogram I-NET panel requirements are mostly seen in staircase projects. The planning and production process is precisely done with the exact dimensions. Ending possibilities of horizontal diamond directed parallelogram I-NET are as below;

**PH1**

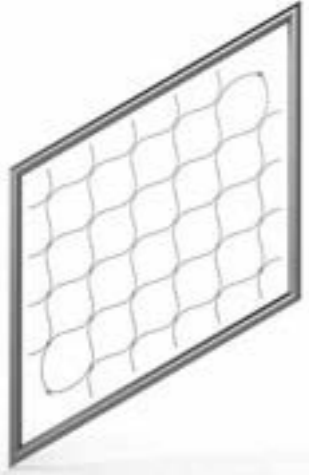

All sides open cable net endings.

**PH2**

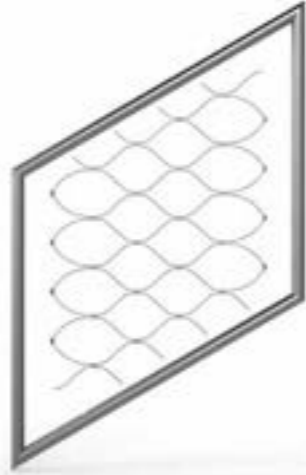

Both sides closed with loose ferrules, two side open cable.

**PH3**



All net sides closed with loose ferrules.

**PH4**

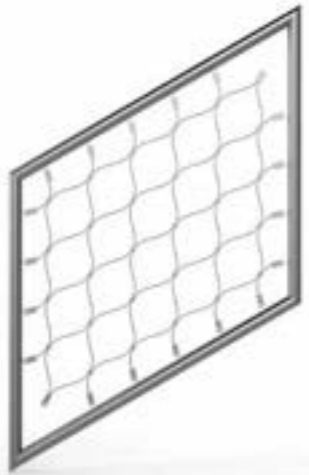

All net sides closed with eyelets.

**PH5**

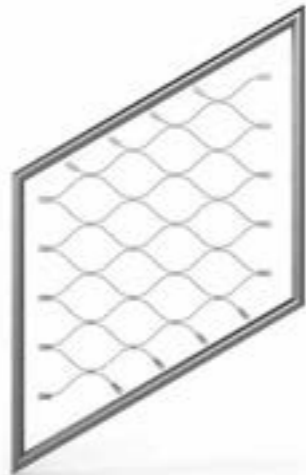

All net sides closed with eyelets.

**PH6**

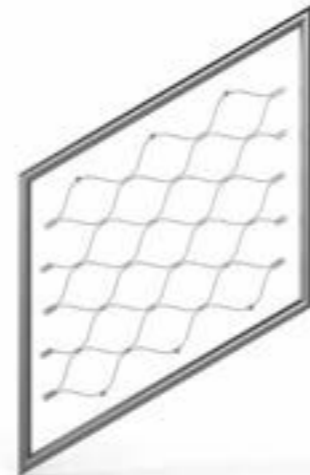

Both sides closed with eyelets, both sides closed with loose ferrules

## I-NET Directions and Endings

### Vertical Diamond Parallelograms I-NET Endings

Parallelogram I-NET panel requirements are mostly seen in staircase projects. The planning and production process is precisely done with the exact dimensions. Ending possibilities of vertical diamond directed parallelogram I-NET are as below;

**PV1**



All net sides closed with loose ferrules.

**PV2**

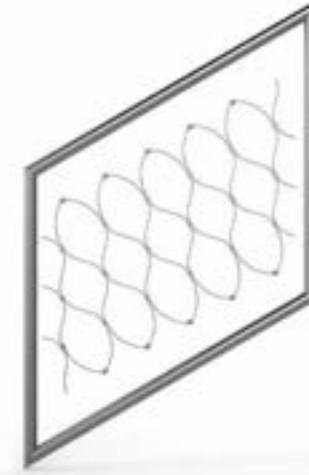

Both net sides open cable, both net sides closed with loose ferrules.

**PV3**



Both net sides closed with loose ferrules, both net sides closed with eyelets.

**PV4**

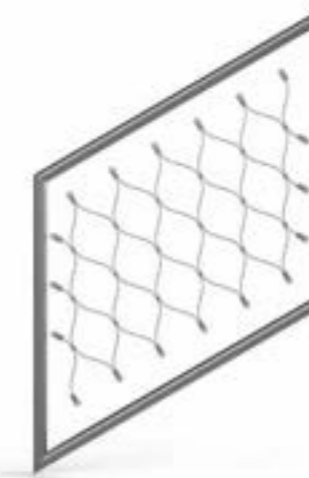

All net sides closed with eyelets.

## Border Ropes and Assembly Details / Closing Details



1. Corner solution, Eye with internal thread swaged fitting



2. Corner solution with external thread fitting and rod fixation



3. Corner connection bracket fixation with fork and swaged fitting



4. Corner solution with rope holder



5. Border cable guidance with clamp ring with two part

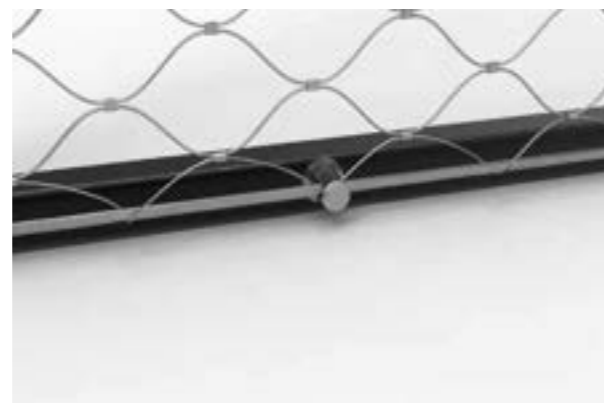

6. Border cable guidance with rope older

## Border Ropes and Assembly Details / Closing Details



7. Corner solution, with fork head rope guiding



8. Corner solution with eye bolt



9. Corner solution with D-Form Shackle



10. Turnbuckle with both side external thread fitting



11. Border cable guidance with connection bracket



12. Border cable guidance with screw on cross clamp

# I-NET FRAME SYSTEMS

## Round Frame Components

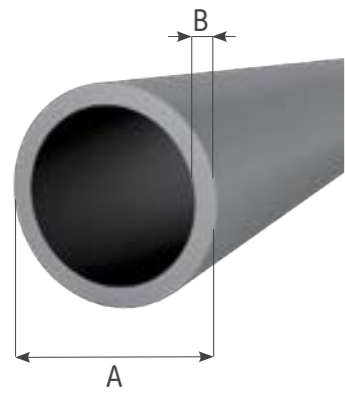
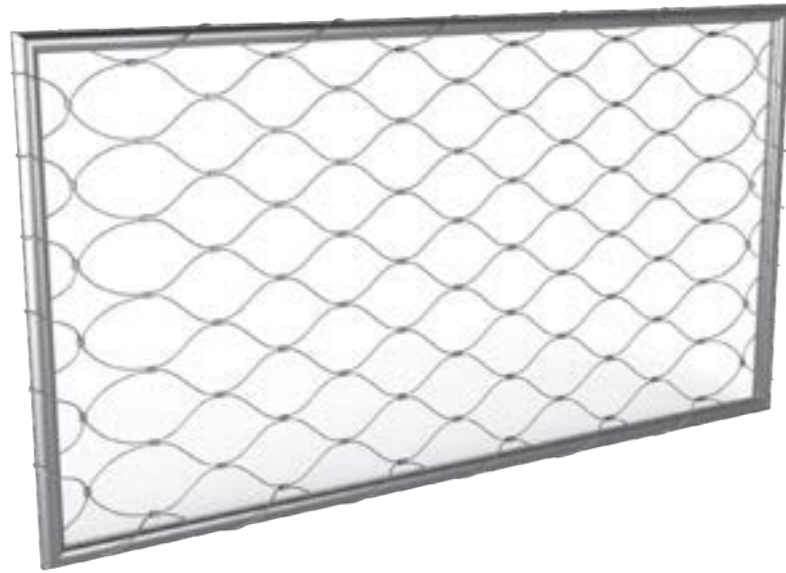

ROUND FRAME

Part Number	Dimensions in mm	
	A	B
IN-F-010-0021-020	21,3	2
IN-F-010-0026-020	26,9	2
IN-F-010-0033-026	33,7	2,6
IN-F-010-0042-026	42,4	2,6

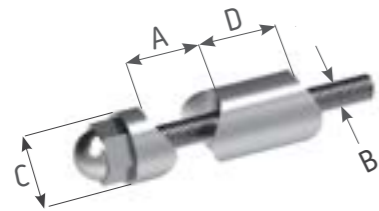

ROUND FRAME HOLDER

Part Number	Dimensions in mm			
	A	B	C	D
IN-F-015-021	21,3	M6	16	25
IN-F-015-026	26,9	M6	16	25
IN-F-015-033	33,7	M8	20	25
IN-F-015-042	42,4	M8	20	25

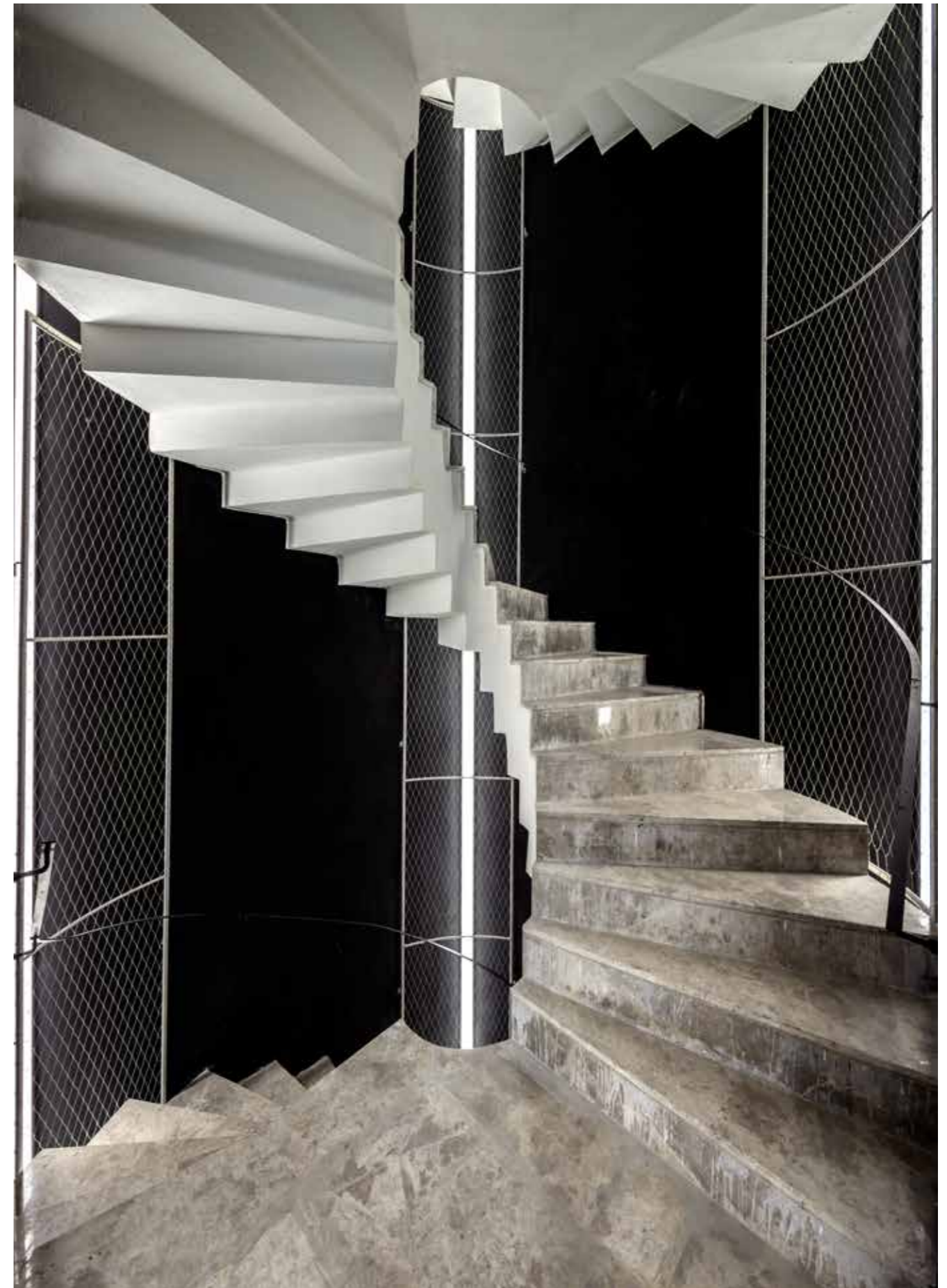

Poliform Head Office / Gebze - Kocaeli - TURKEY

# I-NET FRAME SYSTEMS

## Invis Frame Components

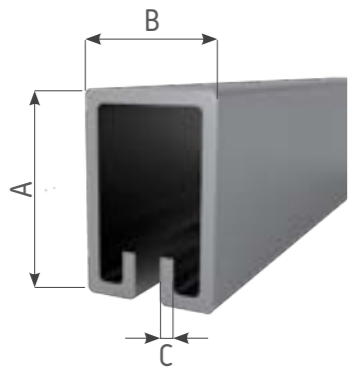

INVISS FRAME

Part Number	Dimensions in mm		
	A	B	C
IN-IF-010-3020-015	30	20	1,5

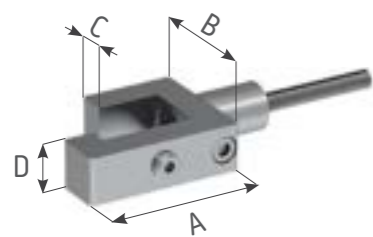

INVISS FRAME HOLDER

Part Number	Dimensions in mm							
	A	B	C	D	E	F	G	H
IN-IF-015-001	55	40	10	15	M6	14	20	M6

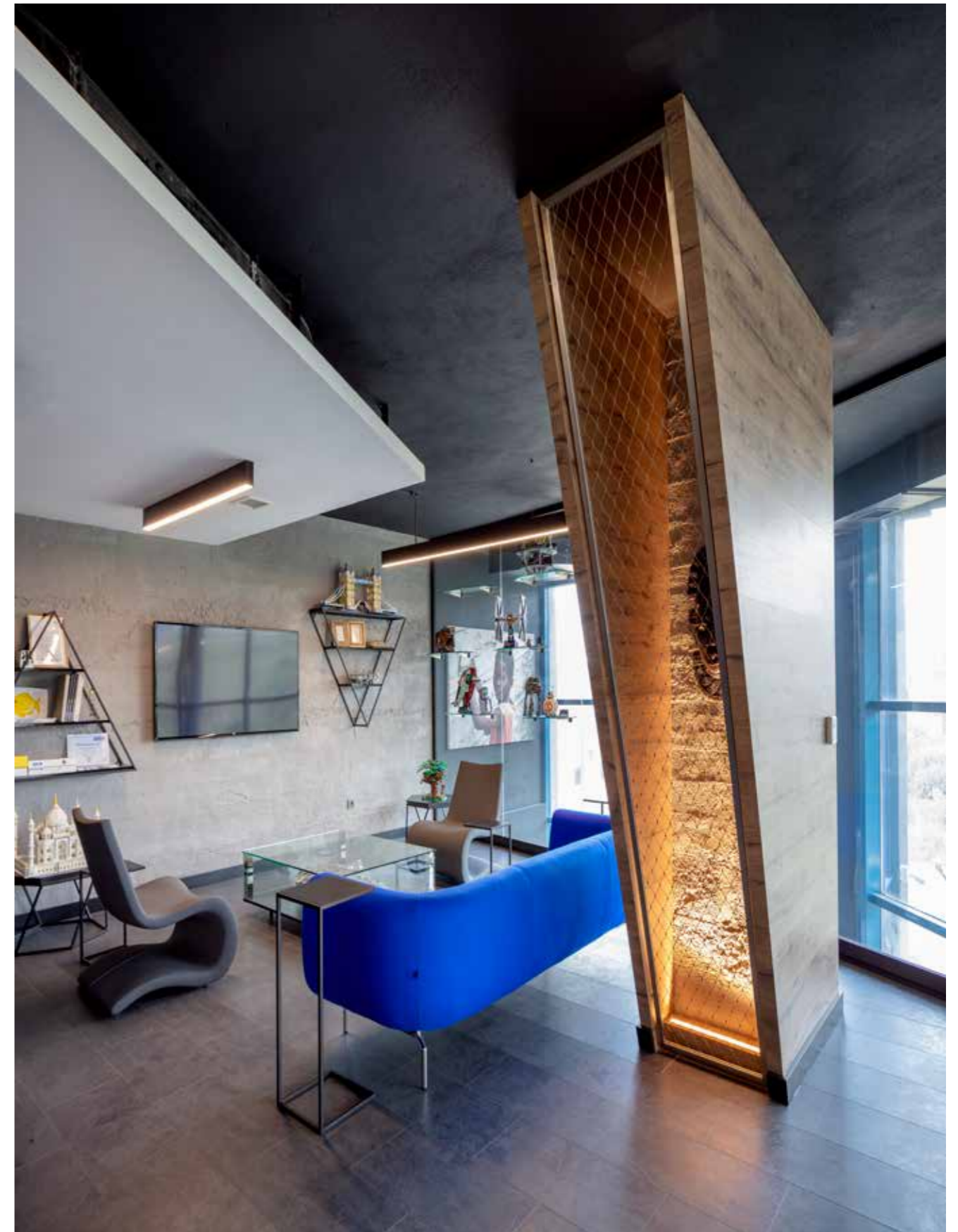

Poliform Head Office / Gebze - Kocaeli - TURKEY

## CHARACTERISTICS OF WIRE ROPES

### Explanation and Application of Wire Ropes

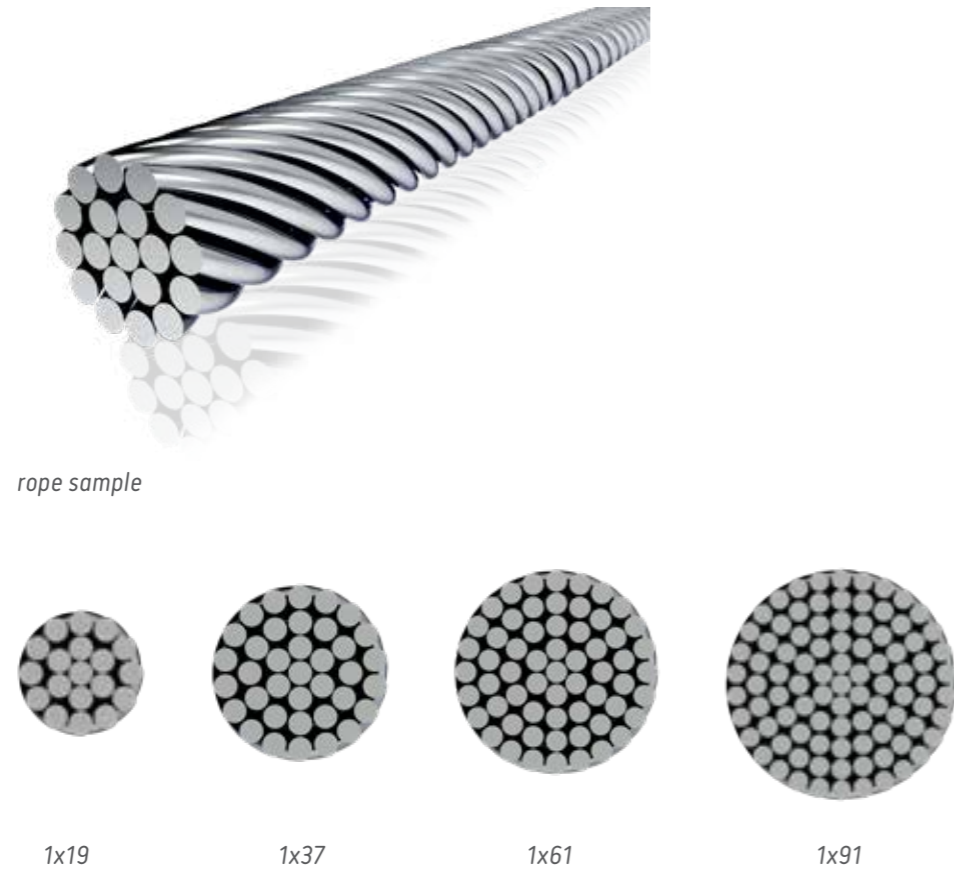

Type of Wire Rope	Explanation
Spiral Ropes	<p>Consist of several layers of individual round wires. They are manufactured from stainless steel wire. If an open spiral rope forms part of a strand rope, it is called "strand". The designation of the various types of wire rope constructions depends on the number of wires in the rope cross section.</p>
Type of Wire Rope	Applications
Spiral Ropes	<p>Carrier cables for lightweight membran structures,                      Carrier/tensioning cables in cable nets,                      Carrier cables for light suspension bridges,                      Hanger cables for suspension bridges,                      Balustrade cables for suspension bridges,                      Bottom flange cables for load-bearing structures.</p>

## CHARACTERISTICS OF WIRE ROPES

### Explanation and Application of Wire Ropes

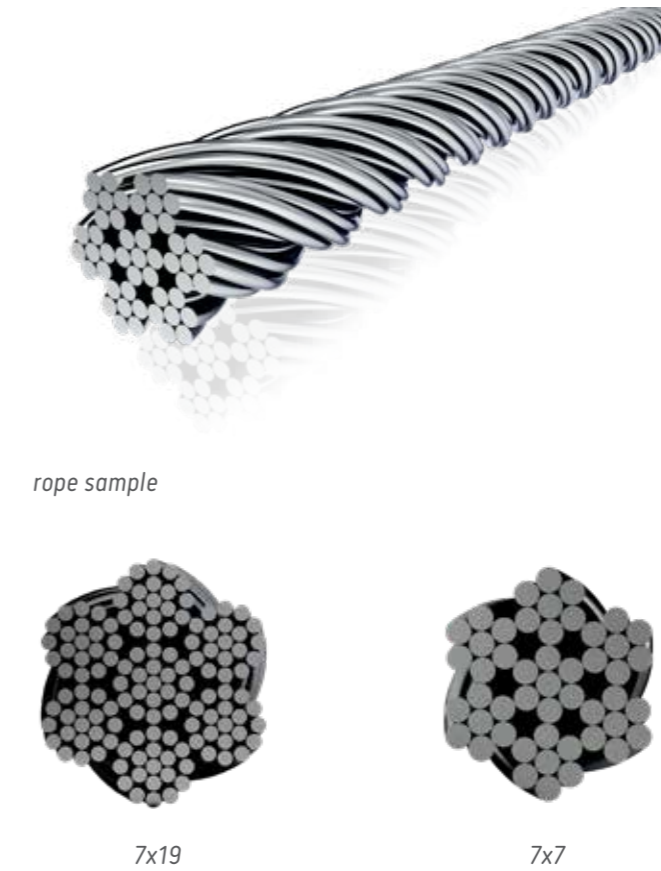

Type of Wire Rope	Explanation
Strand Ropes	<p>Wire ropes consist of a number of strands twisted together. This construction makes them very flexible. The code for this type of wire depends on the number of strands and the number of wires per strand.</p>
Type of Wire Rope	Applications
Strand Ropes	<p>Tensioning cables for lightweight membran structures,                      Hanger cables for suspension bridges,                      Balustrade cables for bridges,                      Bottom flange cables for load-bearing structures,                      Cross-bracing structures.</p>



## Technical Information About Wire Ropes

### SPIRAL / STRAND ROPE "DIN EN 12385-10"

**Material** : Stainless steel wire 1.4401 (AISI 316) to DIN EN 10264-4

**Modulus of Elasticity** : 130 kN/mm<sup>2</sup> ± 10 kN/mm<sup>2</sup>

**Tolerance on Diameter** : 0% / +3%

**Socketing** : D= 4-40mm Swaging

Rope Ø mm	Minimum Breaking Force F <sub>min</sub> [kN]	Charact. Breaking Force F <sub>uk</sub> (1) [kN]	Tension Strength FR <sub>d</sub> (2) [kN]	Metallic Cross Section A [mm <sup>2</sup> ]	Stiffness EA [MN]	Weight [kg/m]
4	13	11.8	7.2	10	1.28	0.1
6	27	24.3	14.7	22	2.86	0.2
8	49	44.1	26.7	39	5.07	0.3
10	76	68.4	41.5	60.7	7.9	0.5
12	110	99	60	88	11.4	0.7
14	149	134.1	81.3	120	15.5	1
16	206	185.4	112.4	154	20.1	1.3
18	261	234.9	142.4	197	25.6	1.6
20	322	289.8	175.6	244	31.7	2
22	389	350.1	212.2	293	38.1	2.4
24	463	416.7	252.5	350	45.5	2.9
26	544	489.6	296.7	410	53.3	3.4
28	629	566.1	343.1	474	61.6	3.9
30	724	651.6	394.9	545	70.8	4.5
32	824	741.6	449.5	618	80.4	5.1
34	929	836.1	506.7	701	91.1	5.8
36	1042	937.8	568.4	784	102	6.5
38	1086	977.4	592.4	838	109	6.9
40	1198	1078.2	653.5	929	121	7.7

*F<sub>min</sub>*: Minimum Breaking Force.

*F<sub>uk</sub>*: Breaking Strength of Wire Ropes Inc. End Connectors.

*FR<sub>d</sub>*: Limit Tension Resistance of the Wire Ropes Inc. End Connectors.

*ke*: Loss Factor.

$$F_{uk} = F_{min} \times k_e$$

$$FR_d = (F_{min} \times k_e) / 1,65$$

$$k_e = 0,9 \text{ (swaged fitting)}$$



## OVERVIEW OF STAINLESS STEEL

### Material

Stainless steel is an iron-based alloy which contains 10,5% chromium. This element keeps it self stain proof by creating a chromium-oxide layer on the surface of the material.

316 is a type of austenitic stainless steel which is a popular grade as 304 with a higher corrosion resistance.

Different to 304 it contains Molybdenum and higher Nickel as well as Chromium contents. Since INOX-NET products are used widely in outer weather conditions. INOX-NET prefers 316 grade because of its better resistance to chemicals and chlorides (like salt). 316L has a better corrosion resistance and welding behaviour containing less Carbon. 316Ti has a better corrosion resistance compared to 316L with its Titanium content and higher friction resistance.

On the other hand Duplex stainless steel has both better corrosion and mechanical properties than 316L and 316Ti. Thus INOX-NET prefers duplex stainless steel for the individual properties requested by special projects.

### MATERIAL GROUPS

	EN 10088-3		AISI	Cmax.	Cr	Ni	Div	Type
AISI 316 group	1.4401	X5CrNiMo17-12-2	316	0.07	18	10		Austenitic
	1.4404	X2CrNiMo17-12-2	316L	0.03	17	11	Mo	Austenitic
	1.4408	GXCrNiMo19-11-2		0.07	19	10		Austenitic
	1.4435	X2CrNiMo18-14-3	316L	0.03	18	12		Austenitic
	1.4571	X6CrNiMoTi17-12-2	316Ti	0.1	18	10	Ti	Austenitic
Duplex group	1.4462	X2CrNiMoN22-5-3	2205	0.03	21-23	4,5-6,5	Mo	Austenitic-Ferritic
	1.4410	X2CrNiMoN25-7-4	2507	0.03	24-26	6-8	Mo	Austenitic-Ferritic
Designation	European		USA	Carbon	Chromium	Nickel	Ti = Titanium	
	Standard		Standard				Mo = Molybdenum	

### CRITERIA OF DIFFERENTIATION AISI 316 / DUPLEX

	AISI 316		Duplex
Material Number	1.4401	1.4404	1.4462
	1.4408	1.4435	1.4410
	1.4436	1.4571	
Properties	weather-proof		weather-proof
	highly acid-resistant	highly acid and corrosion resistant highly resistant to aqueous environment and seawater higher mechanical properties	



## Corrosion

Although stainless steel is resistant to corrosion by its self passivation mechanism rust may occur in some situations.

Some reasons of rust;

- Contamination by iron particles in the atmosphere or by iron dust from the nearby operations such as grinding, drilling and cutting.
- Lack of cleaning.
- Defects in design selecting the correct grade, finishing .
- Combination with other materials only stainless steel fasteners should be used on stainless steel components.

## How To Avoid Corrosion?

- Correct and appropriate grade should be selected for the environment during the design phase (AISI 304, AISI 316 are not resistant to the sea water and chloridic water, AISI 316 has a limited resistance to seawater, Duplex is resistant to seawater).
- Stainless steel should be cleaned often enough to maintain a good appearance and preserve corrosion resistance.
- Keep away from hydrochloric acid, chloride or fluoride.

## Maintenance and Cleaning

- Rinse with water to remove dirt. High pressure jet cleaners can be used.
- Wash with warm water containing soap or %5 ammonia using a soft brush.
- To remove rust use domestic cleaning creams or polishes which may contain calcium carbonate or citric acid.
- Soft cleaning cloths.

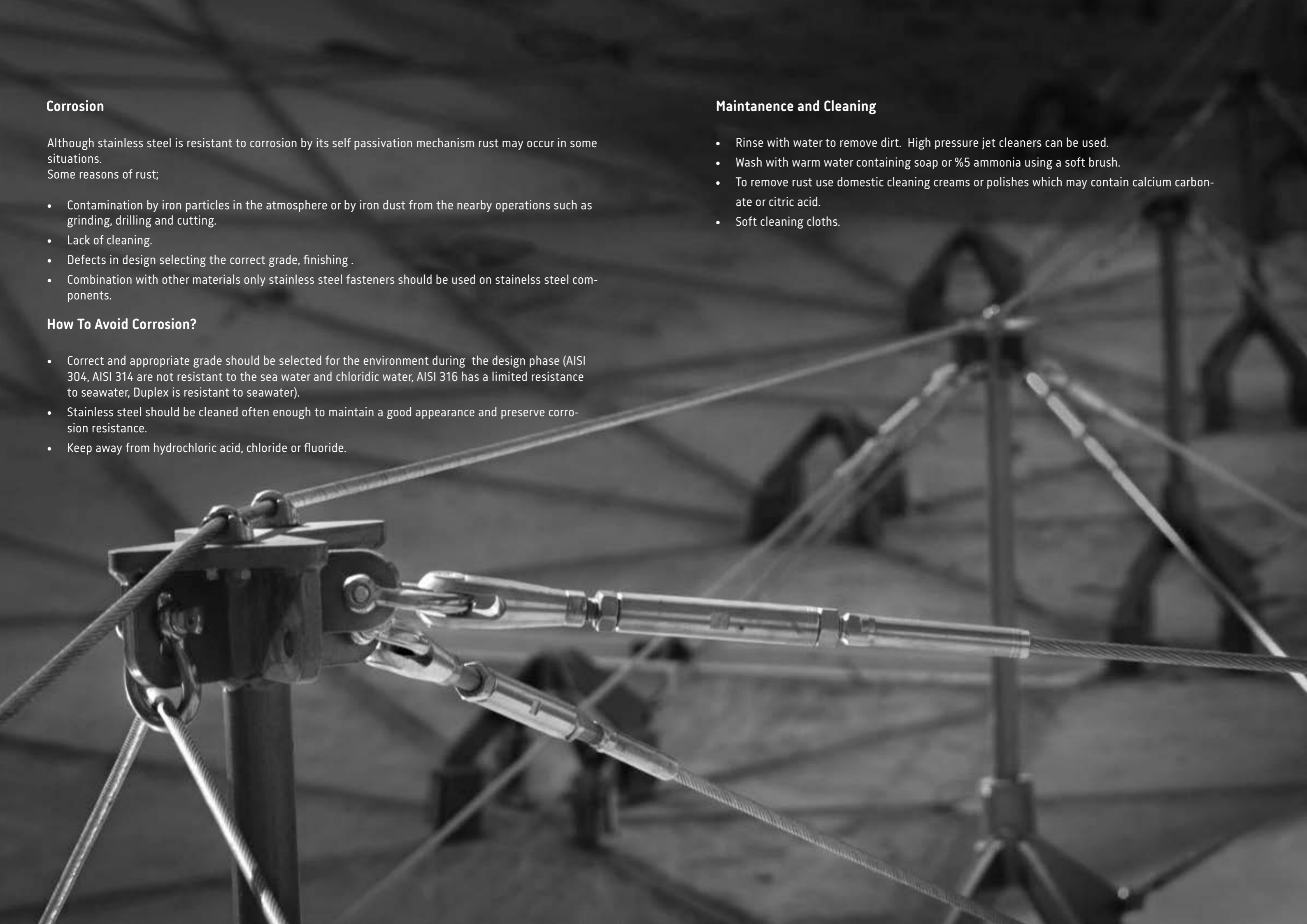

## TECHNICAL TIPS

### ROPE FORCES AND TENSIONING

To make up an effective total, rope force and preload force should be applied as a combination. The ropes are held by means of fittings such as end stops and nuts. The length of the rope can be adjusted by the help of this joints.

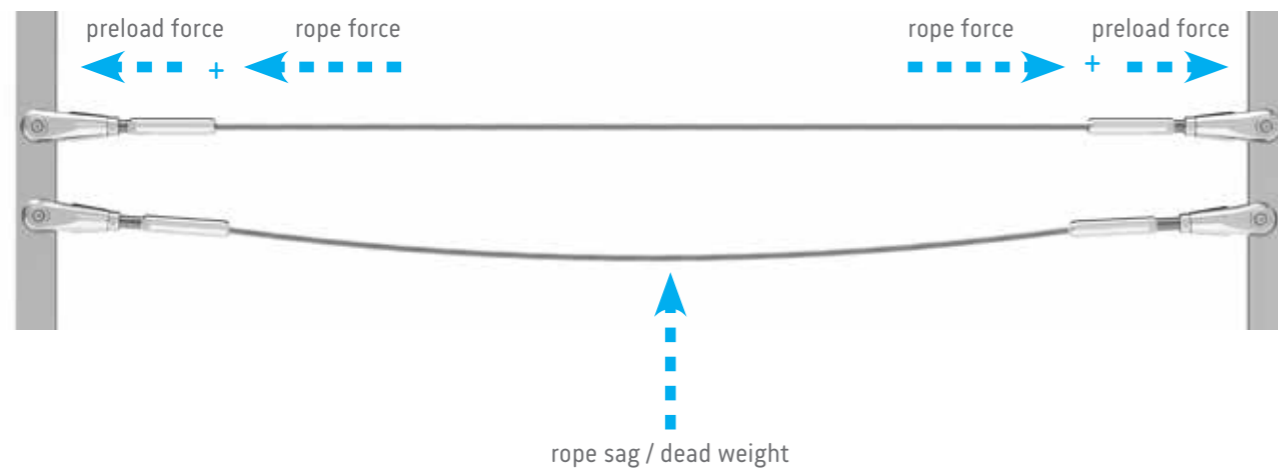

### Tightening and Loosening Descripton of Rope System

#### Right Hand / Left Hand Thread

Where it is not possible to tension the rope from outside then a rope configuration with right hand /left hand thread should be used. The tensioning and releasing is effected by turning the entire rope. Both side right or both side left hand thread is used where the rope can be tensioned from outside.

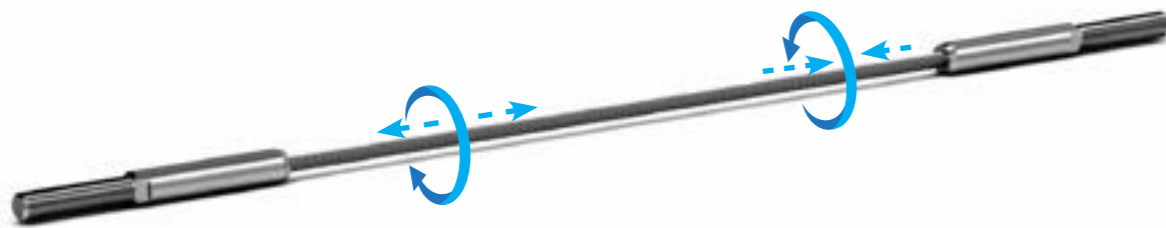

## ASSEMBLY LENGTHS

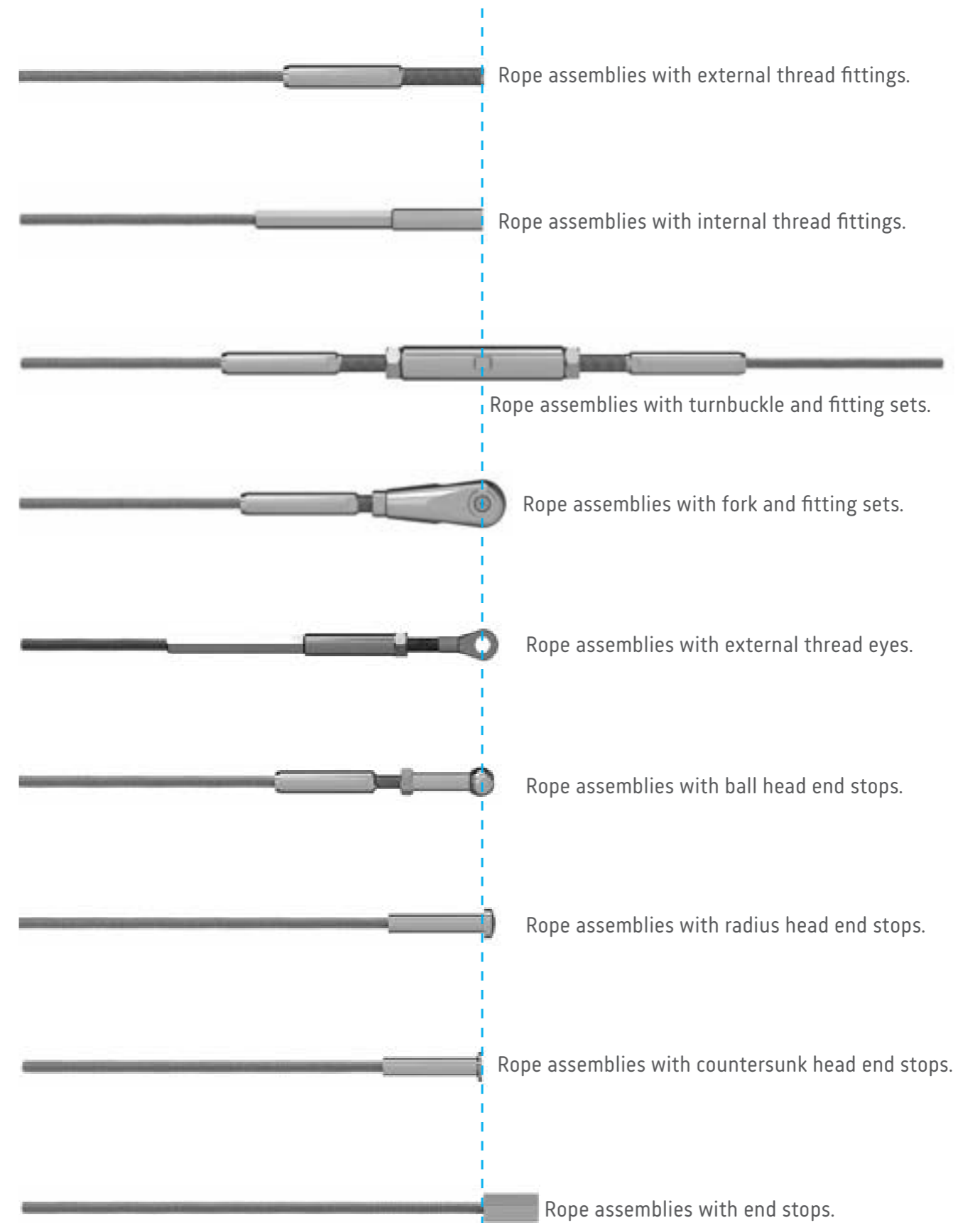

*\*reference line for production dimension*



## OUR GOALS

As INOX-NET we have recently begun establishing new services in Turkey, however our factory and office goals are:

- Our goals as a company is to introduce our products within Turkey and the world. To provide our best services putting our product quality in the forefront while always ensuring customer satisfaction.
- Being the preferred company due to its professional management, which delivers absolute quality both at home and abroad,
- Being the first choice company by creating a working environment where employees are happily working as a member of the INOX-NET family.
- To demonstrate our quality all over the world, to increase our reputation and to expand our core competencies and competitiveness while competing,
- To continuously improve our research and development activities for a portfolio containing economic, high-quality and innovative products.



 **vomet**  
PRIEMYSELNÉ SÚTA